

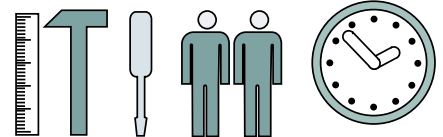

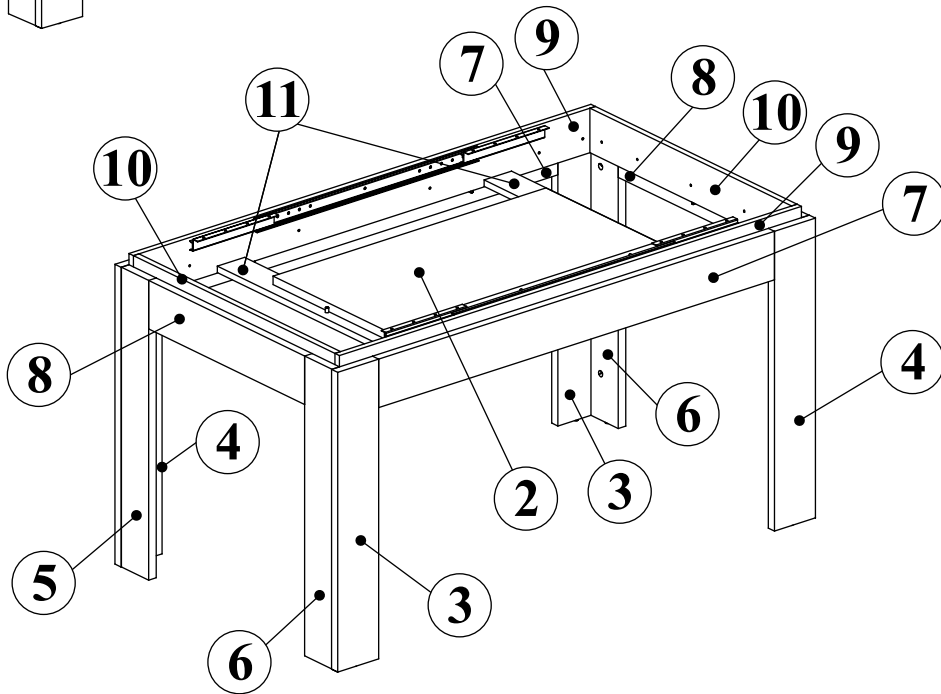

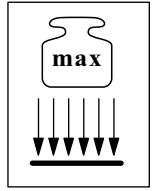

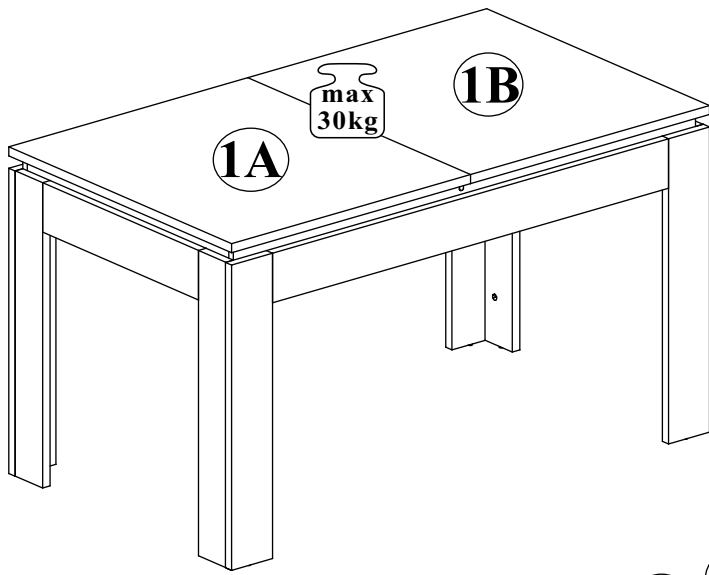

# STONE 83-539-D5-6

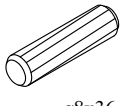
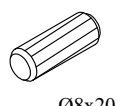
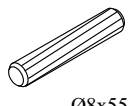
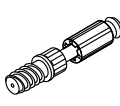

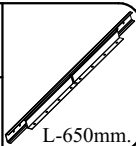
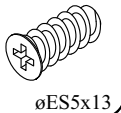
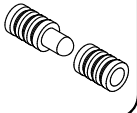
90 min

NO	Dim.		Col.-No	Qty
1A / 1B	800	700	1	2
2	800	400	1	1
3	741	120	1	2
4	741	120	1	2
5	741	98	1	2
6	741	98	1	2
7	1160	120	1	2
8	560	120	1	2
9	1354	110	1	2
10	724	110	1	2
11	724	80	1	2

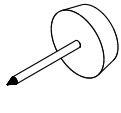
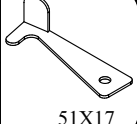
STONE 83-539- D5-6

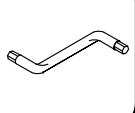
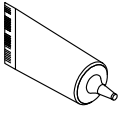
A1 x16  ø8x36	A2 x8  Ø8x20	A8 x16  Ø8x55	B4 x8 	B16 x24  ø15x12	G5 x24 
H9 x2  L-650mm.	D8 x28  øES5x13	KU x6 	B6 x8  Ø7x76	B11 x8  Ø7x50	G4 x8 
UP16 x22  UPØ4x35	I2 x8 	SZS x4  51X17	D10 x8  ø3,5x13	G2 x1 	G1 x2 

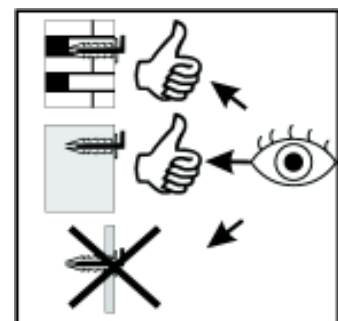
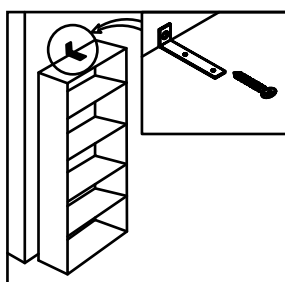
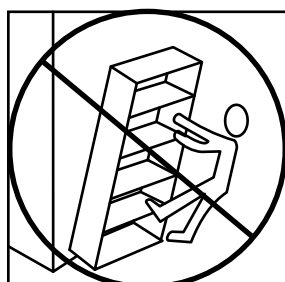
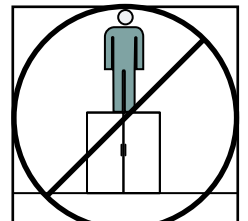
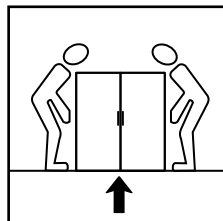
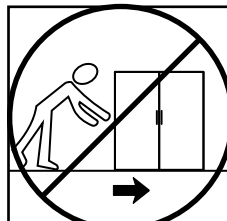
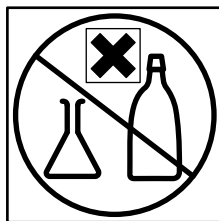
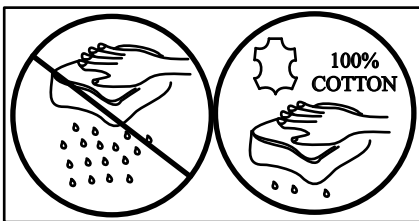
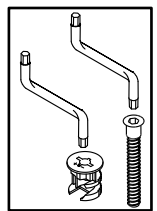
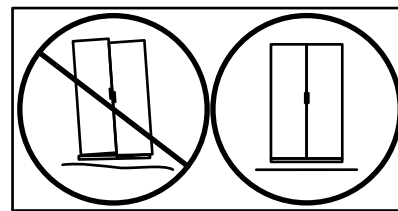
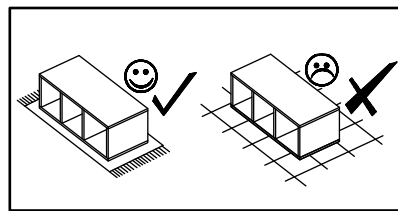
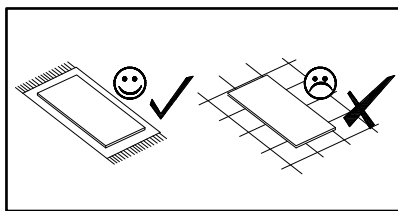
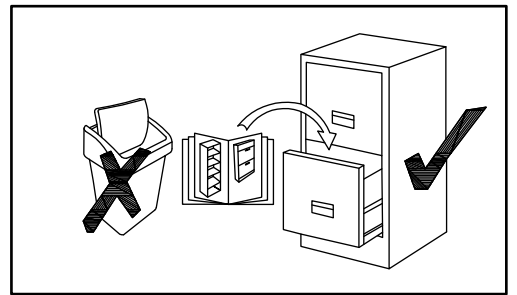
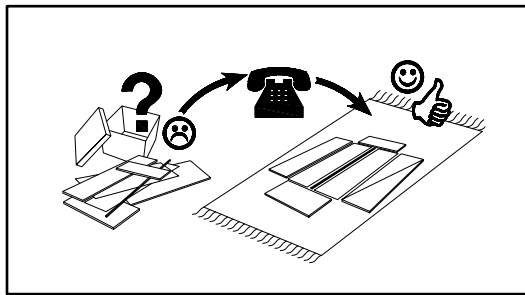
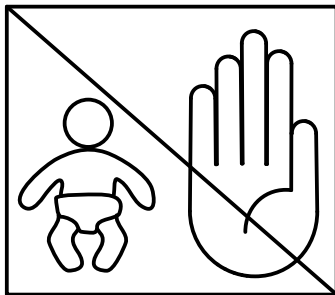
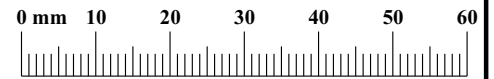

1

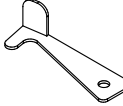
SZS	
x2	51X17

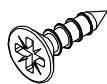
D10	
x4	ø3,5x13

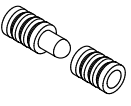
KU	
x3	

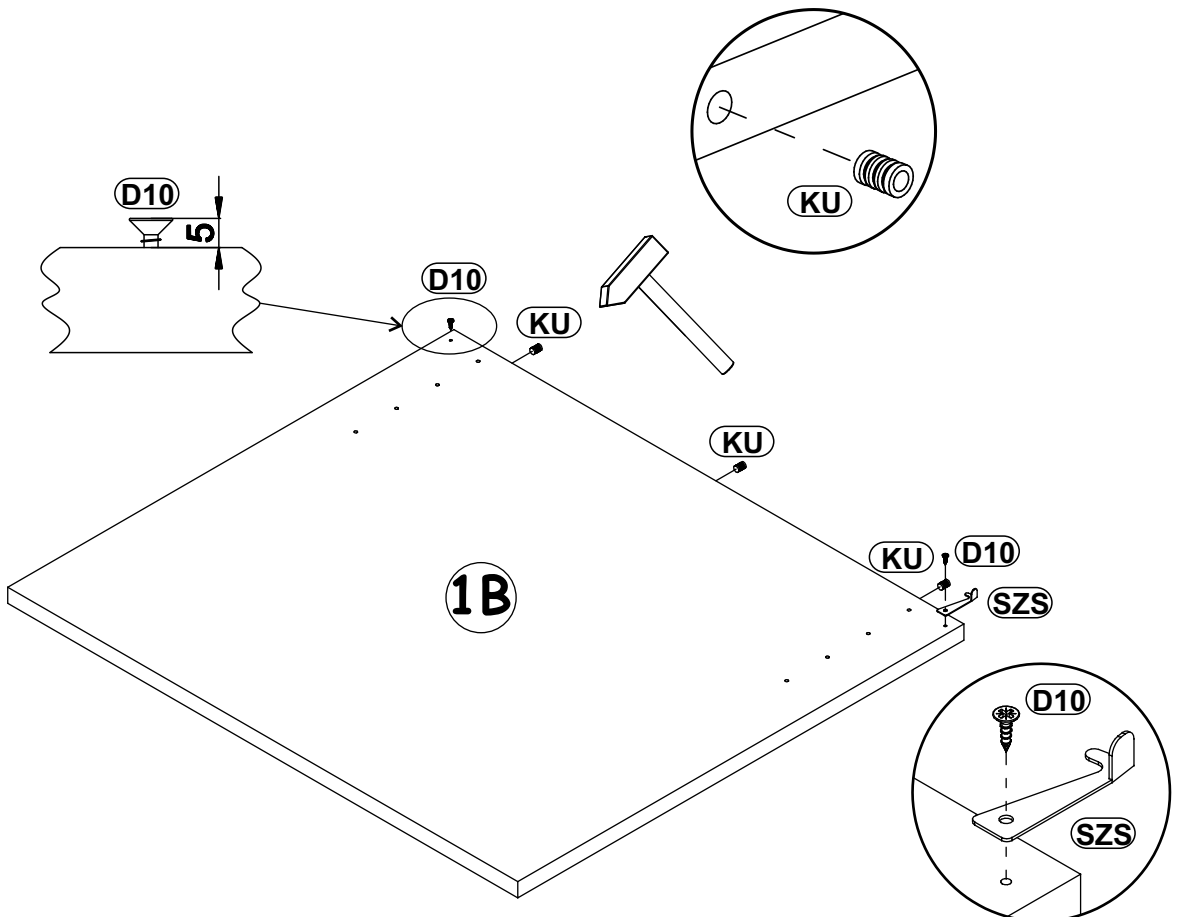
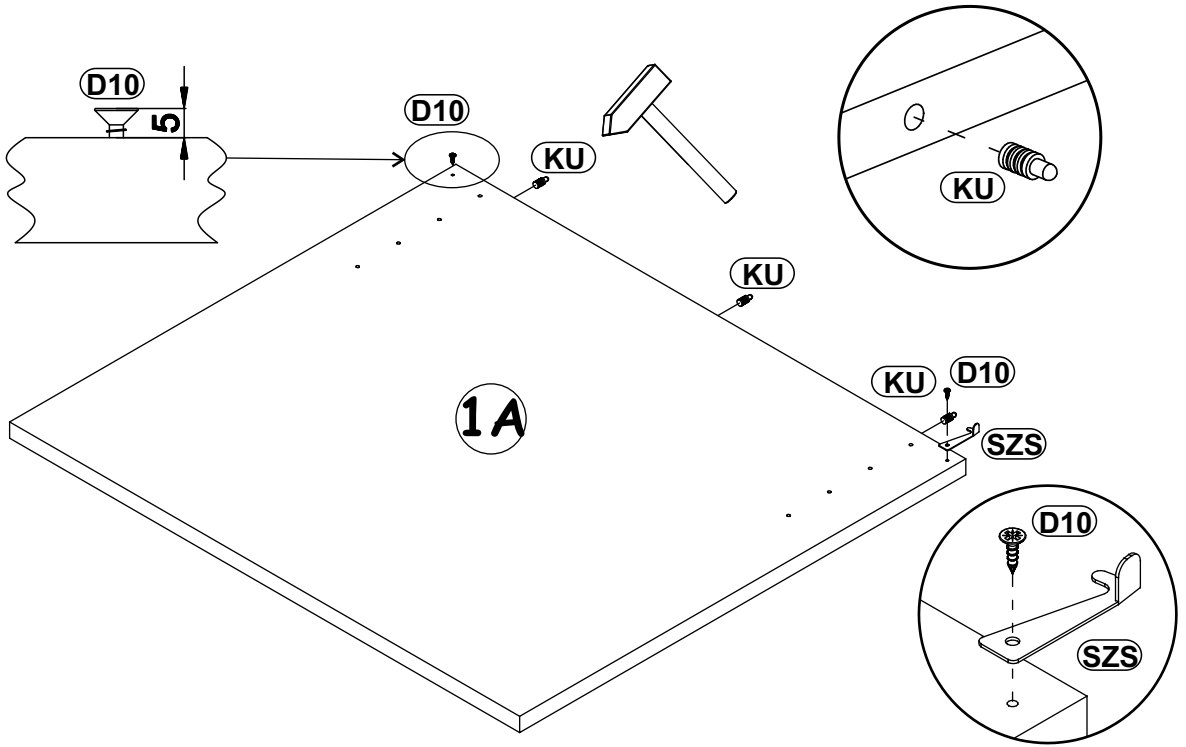

2

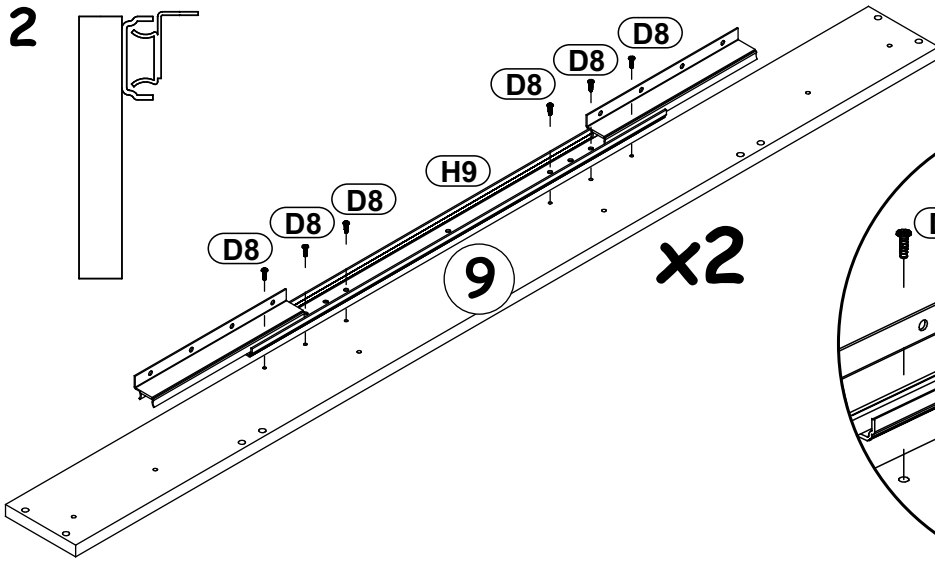

H9		D8	
x2	L-650mm.	x12	øES5x13

3

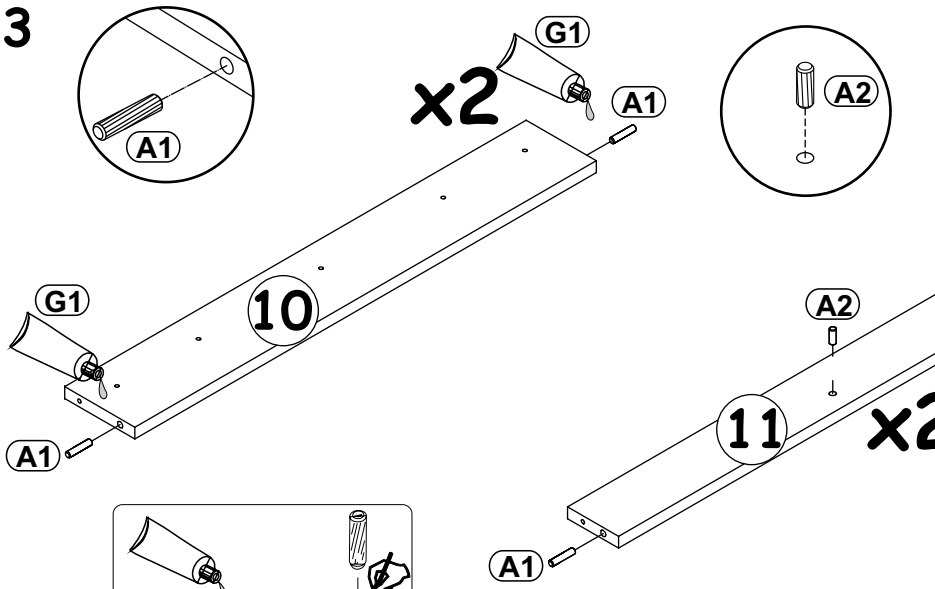

A1		A2	
x8	ø8x36	x2	ø8x20
<del>A8</del>		<del>ø8x55</del>	
G1			
x1			

4

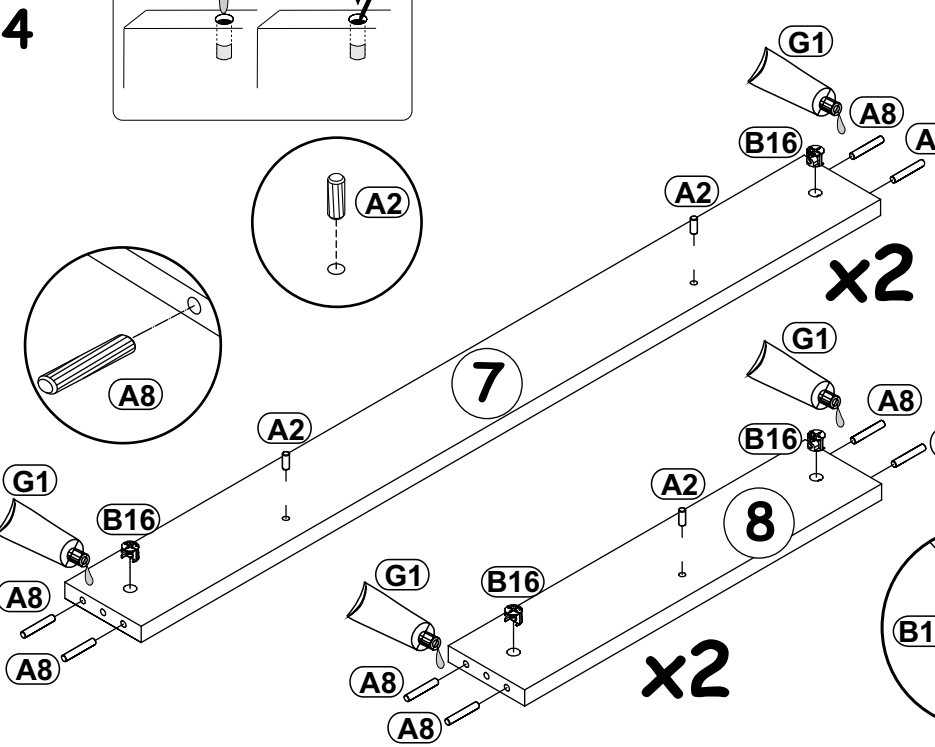

G1		B16	
x1		x8	ø15x12
<del>A8</del>		<del>ø8x55</del>	
A2		A8	
x6	ø8x20	x16	ø8x55
<del>A1</del>		<del>ø8x36</del>	

5

KU		SZS		D10	
x3		x2	51X17	x4	ø3,5x13

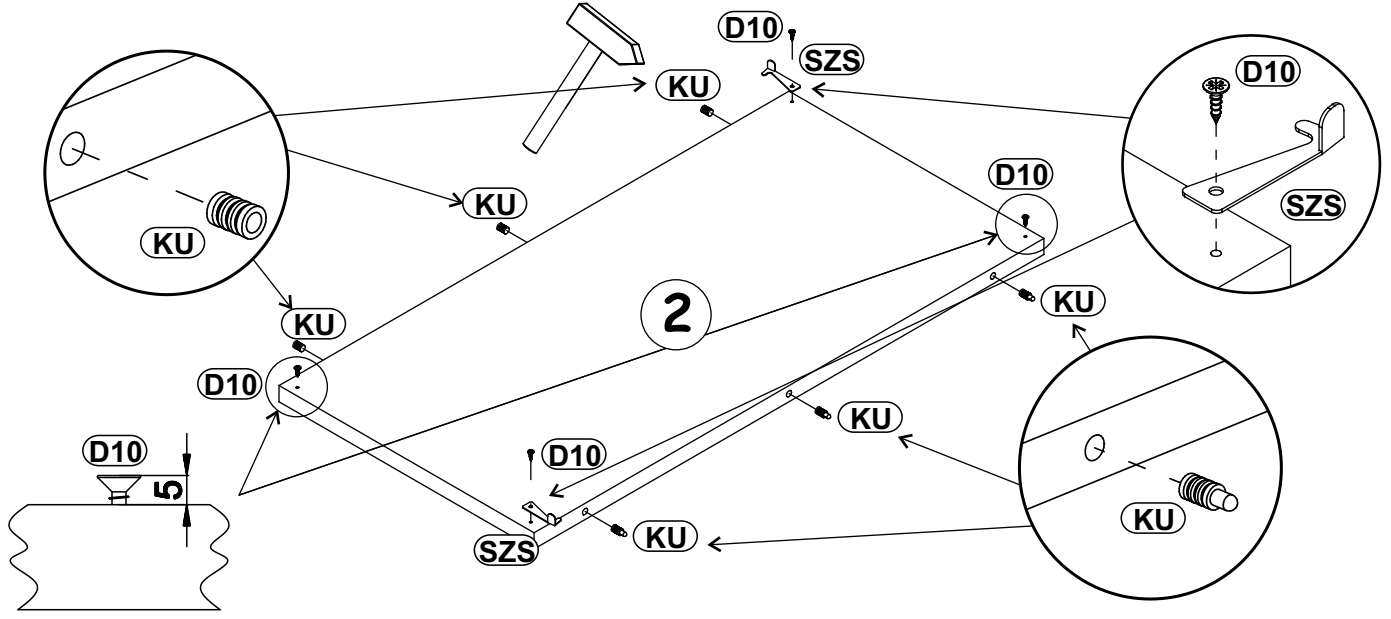

6

B4		B16		I2	
x8		x16	ø15x12	x8	
A1		A2		A8	
x8	ø8x36	<del></del>	<del>ø8x20</del>	<del>ø8x55</del>	
G1					
x1					

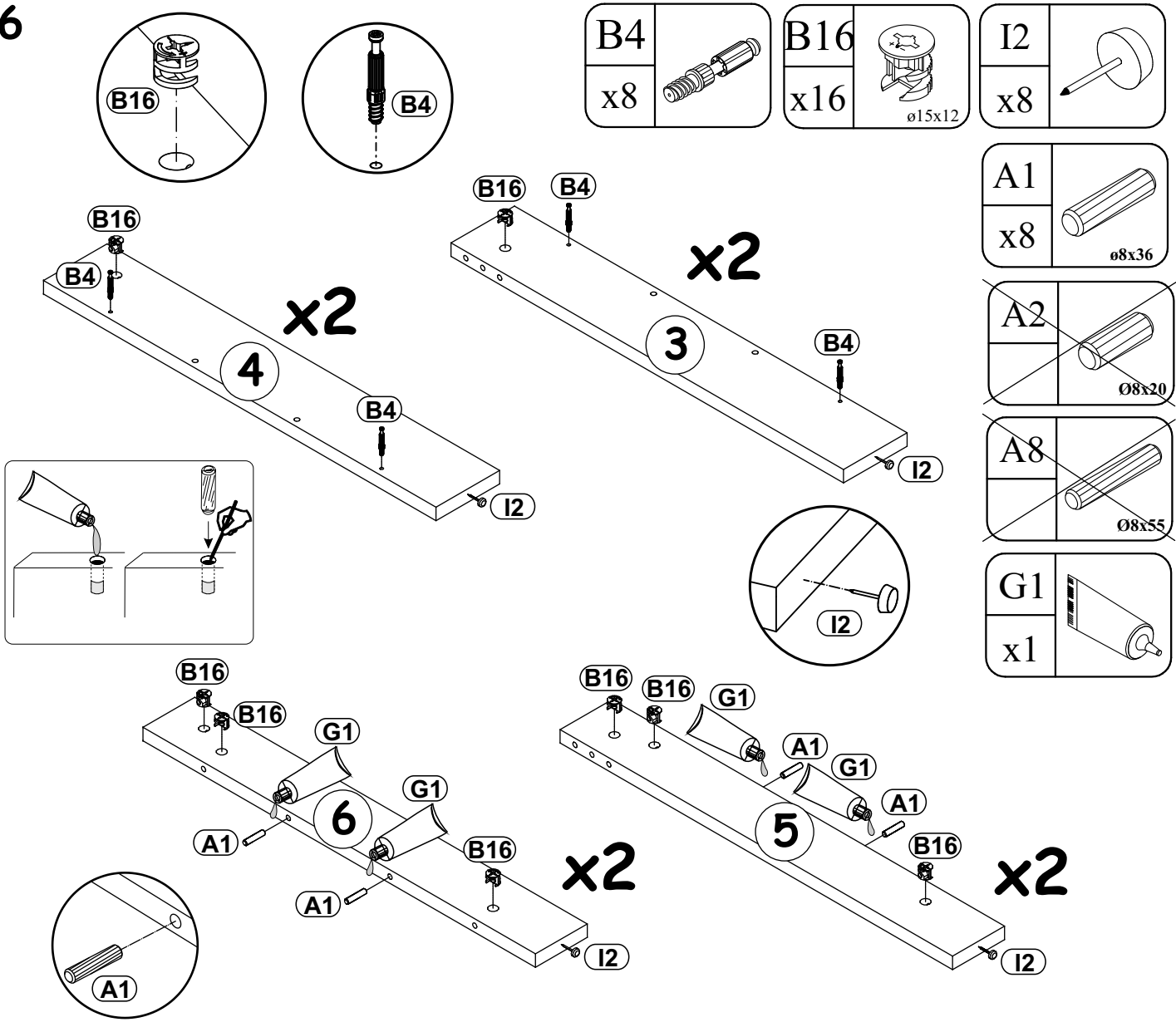

7

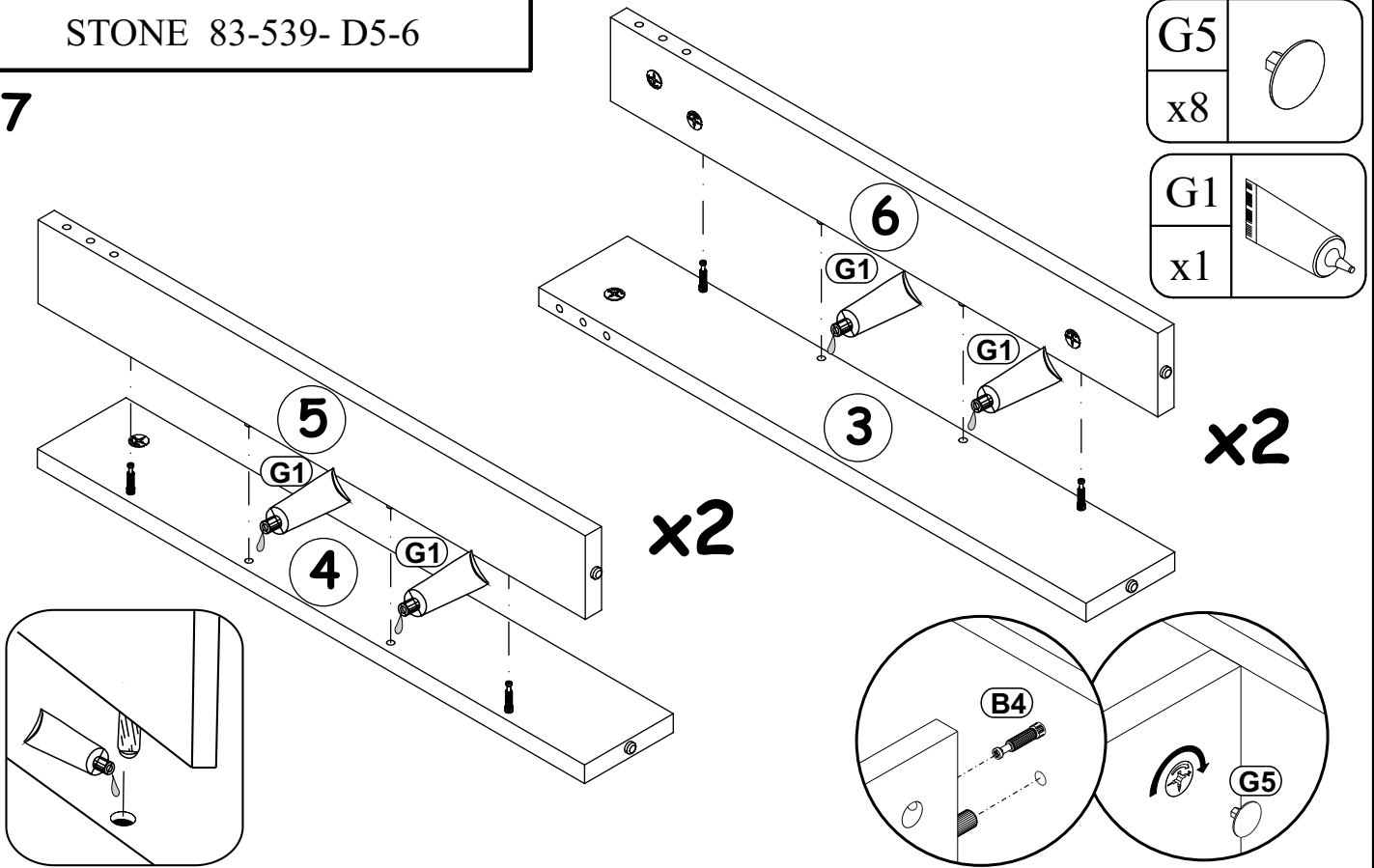

G5	
x8	

G1	
x1	

8

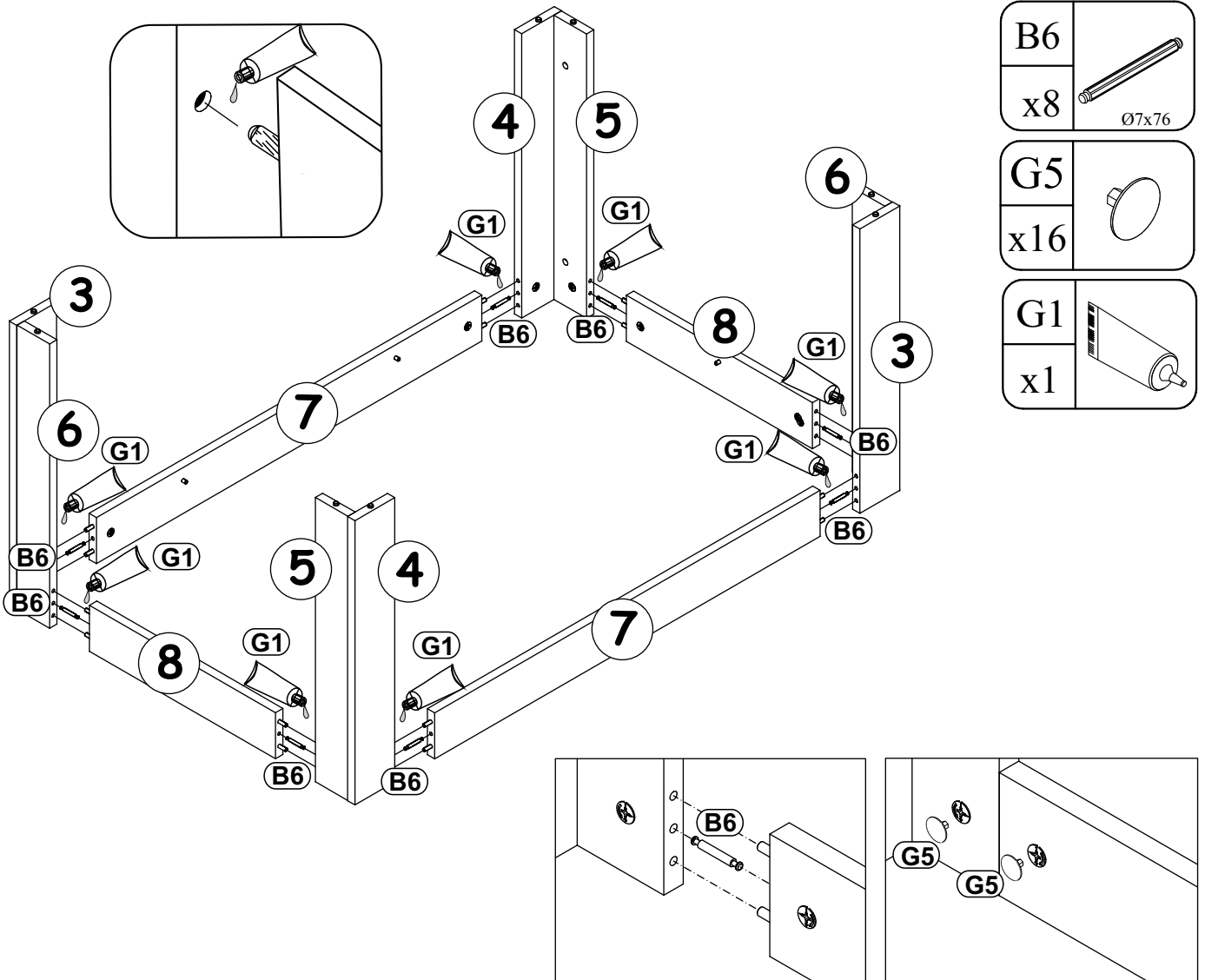



B6	
x8	Ø7x76

G5	
x16	

G1	
x1	

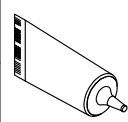
9

G1	
x1	

B11	
x8	Ø7x50

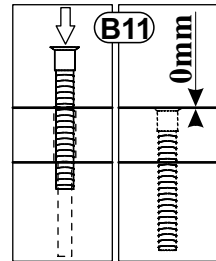
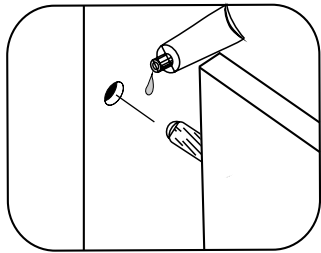
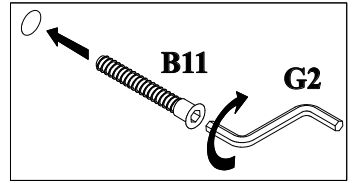
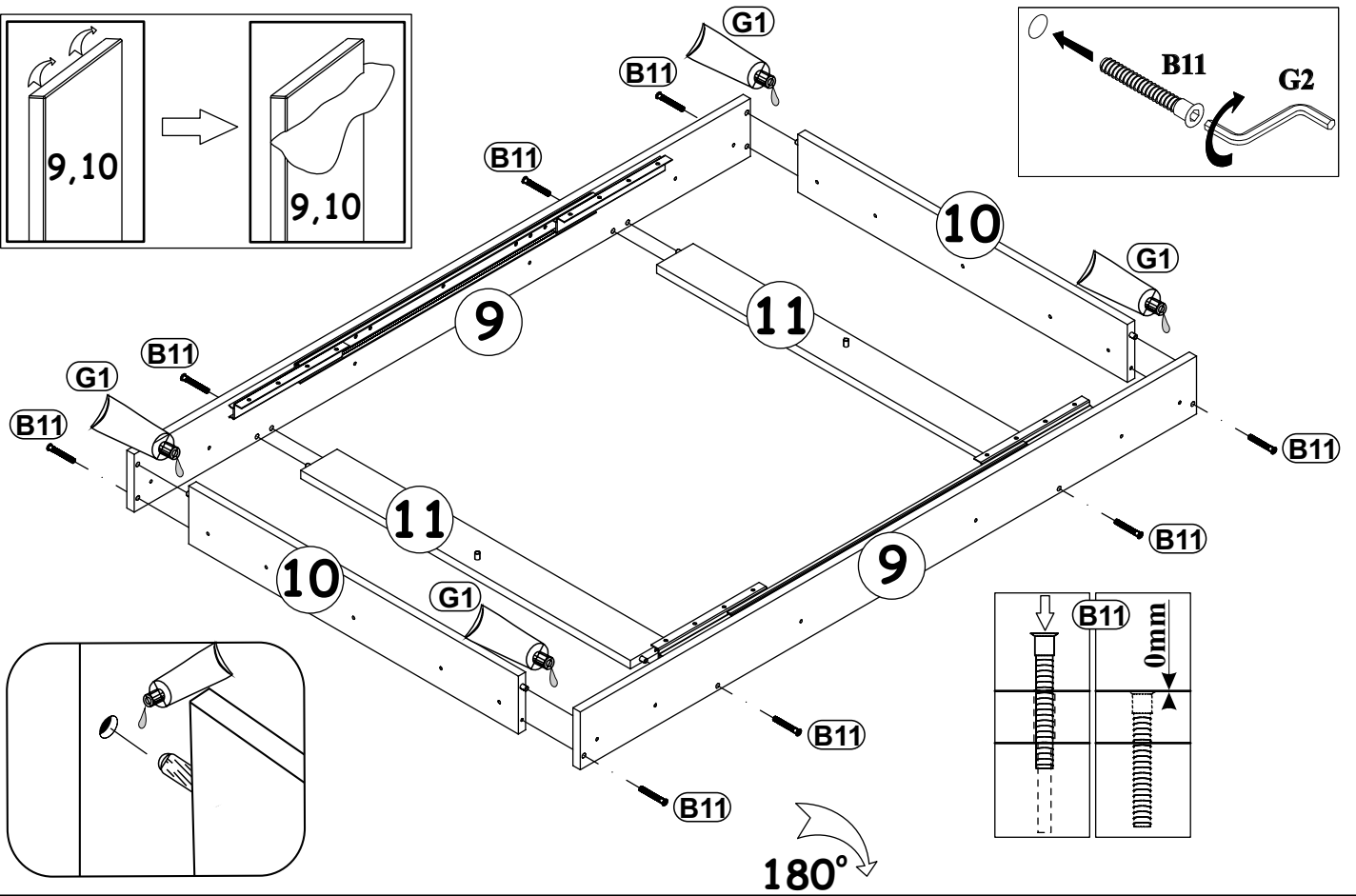
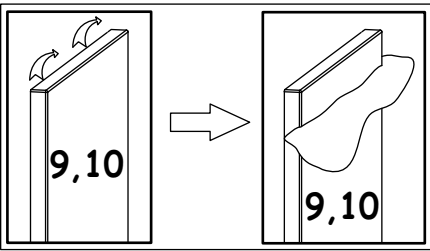

180°

10

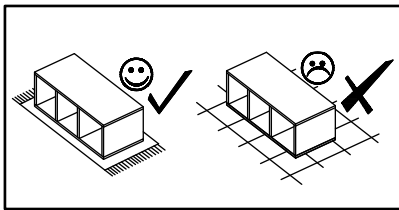

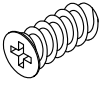
D8	
x16	øES5x13

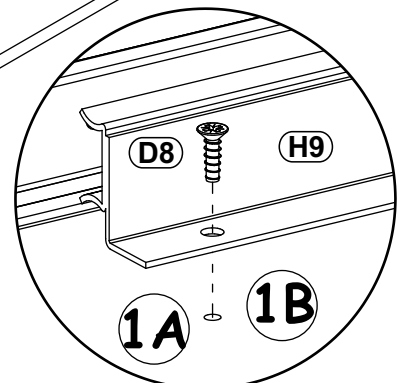
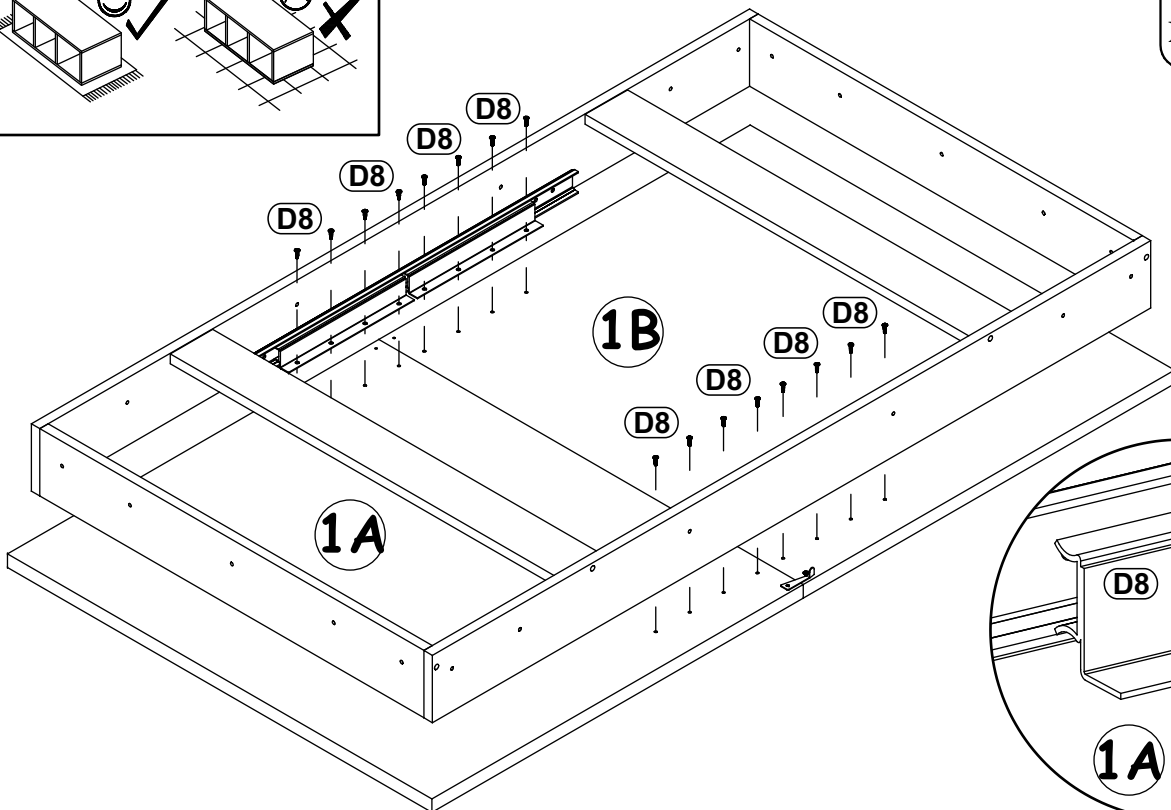

11

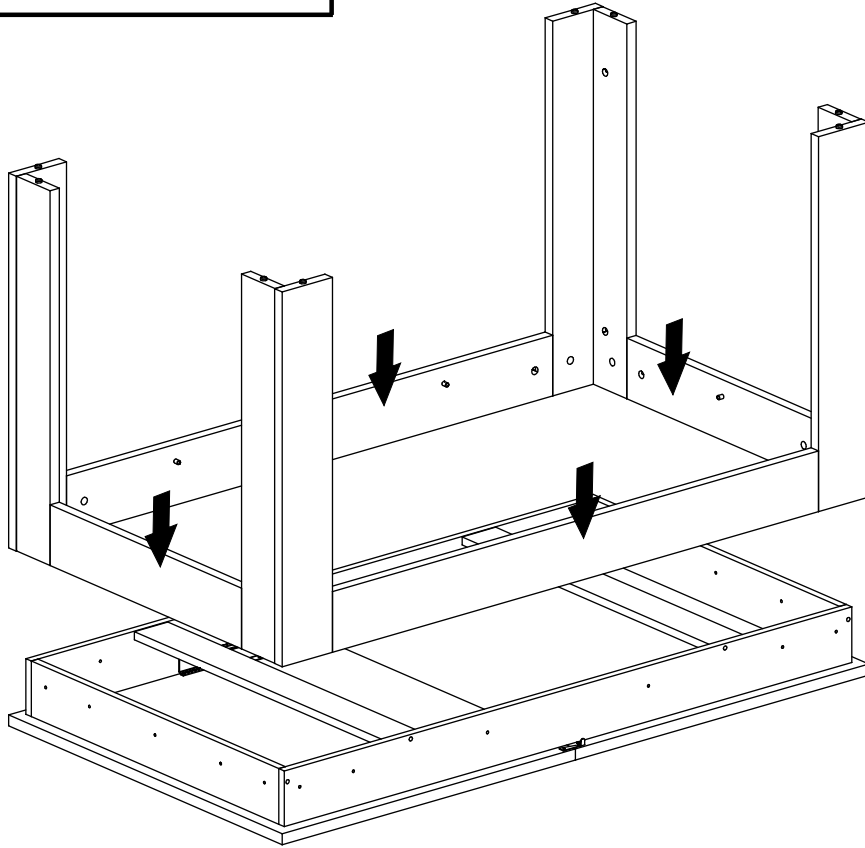

12

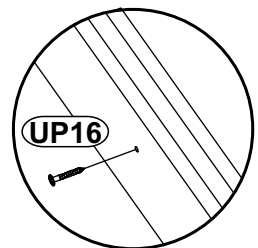
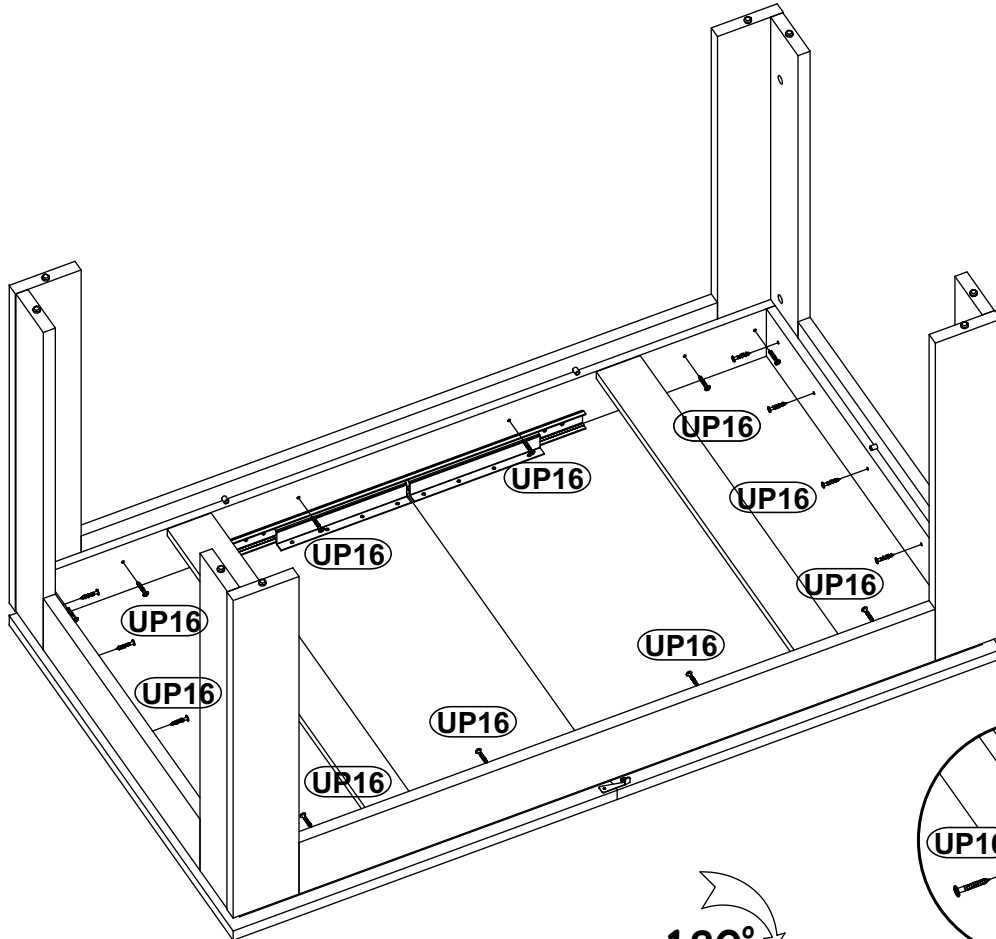
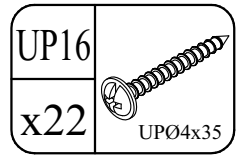



13

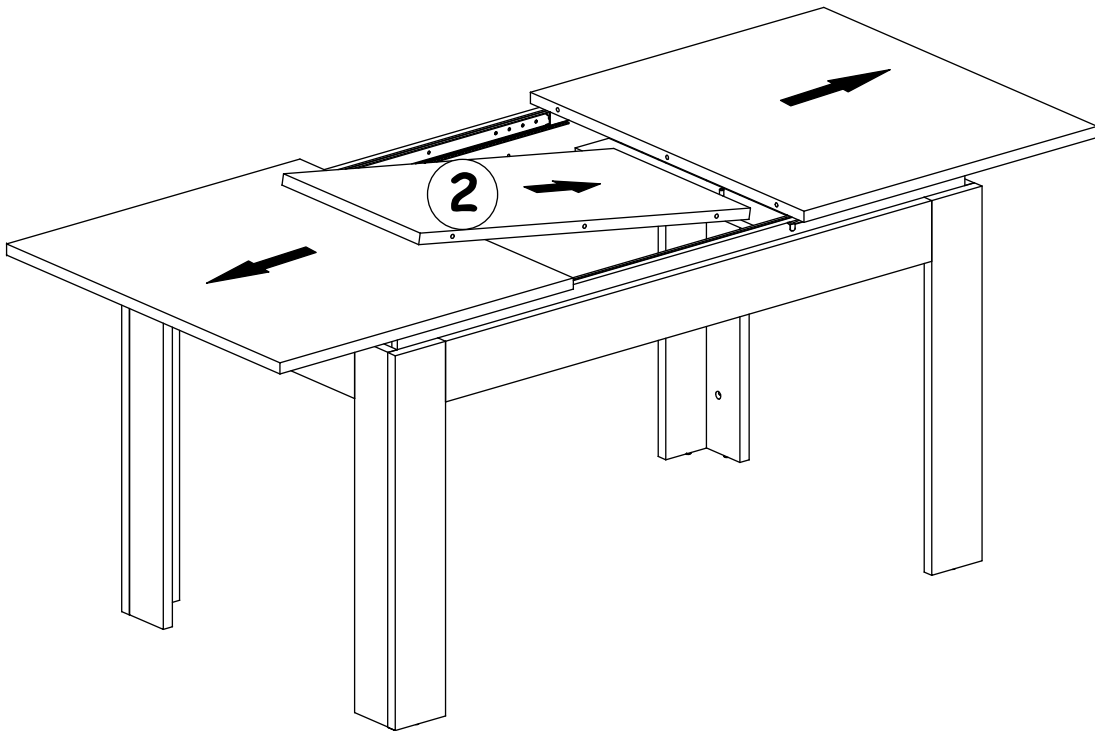

14

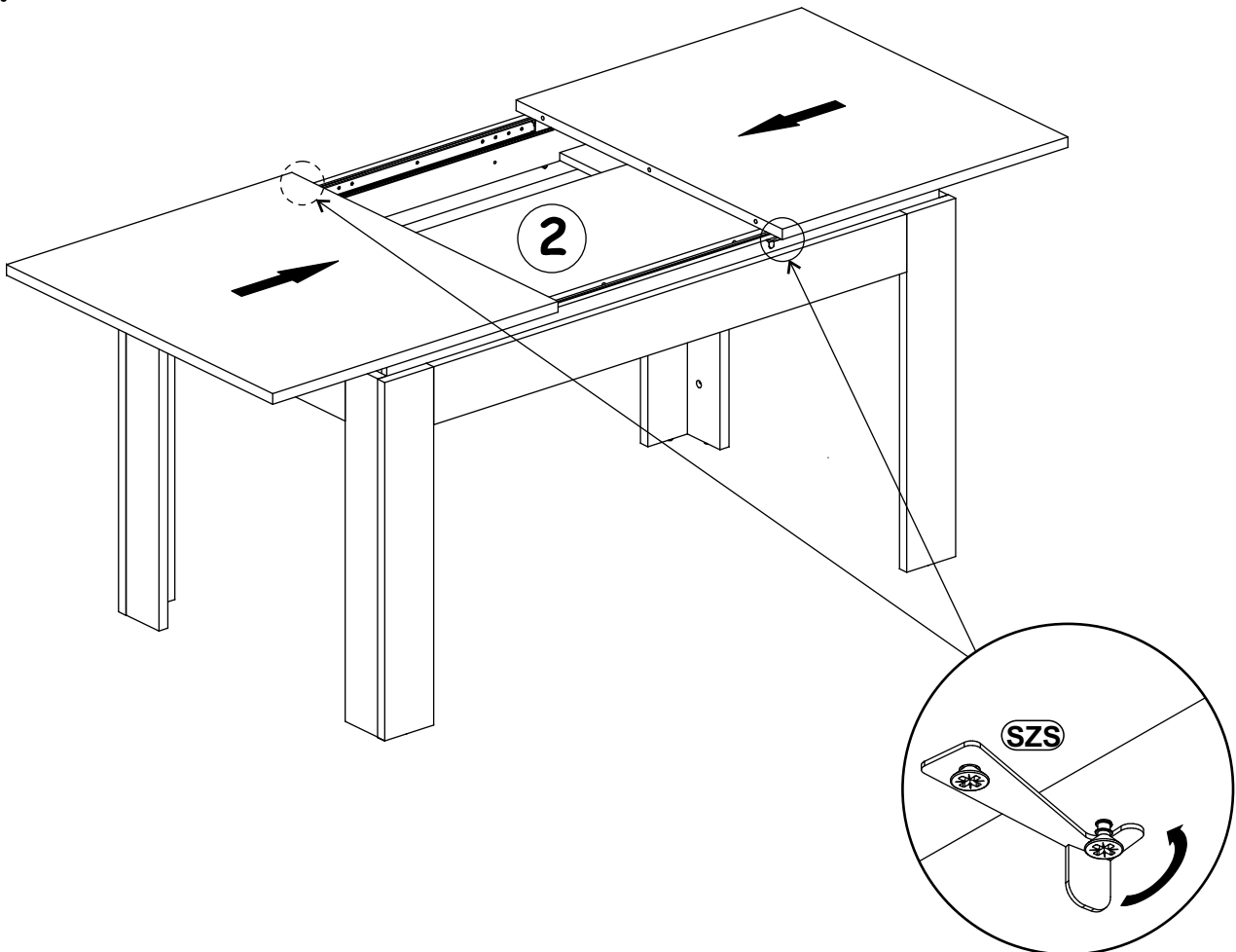

15

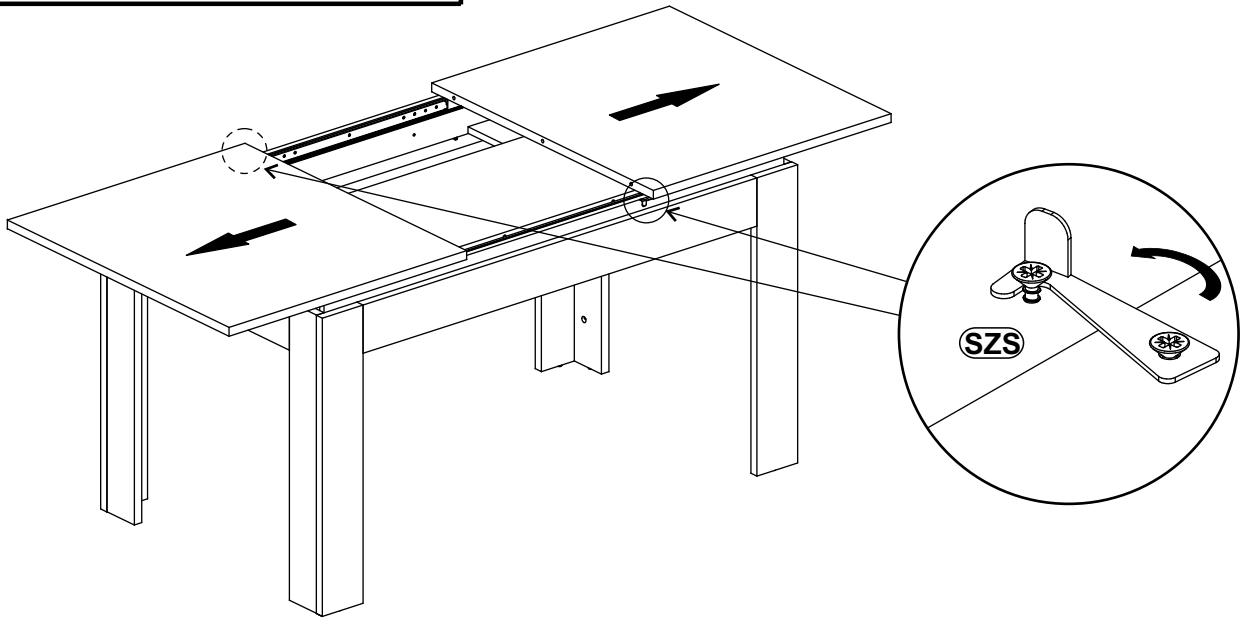

16

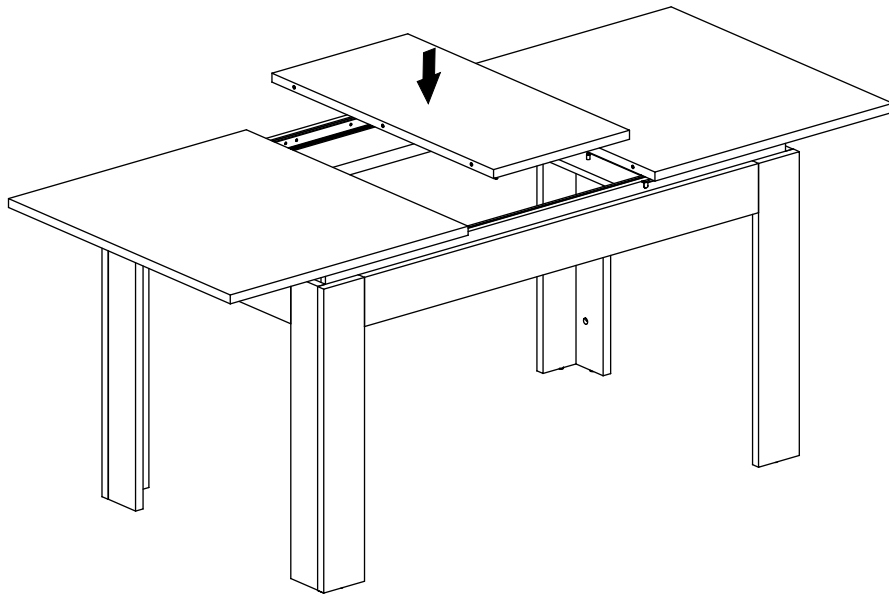

17

